

A yellow tracked excavator is shown in action, dumping a large quantity of brown material from a green Cobra attachment into a large pile. The attachment is tilted, and a significant amount of dust or fine particles is being released as the material falls. The background shows a clear blue sky with some clouds and a distant treeline. The excavator's arm and tracks are visible on the right side of the frame.

# COBRA

ATTACHMENT FOR SCREENING AND CRUSHING

**Cobra** Cernos



# COBRA SCREENING BUCKET

---

With Cobra Screening Bucket you can effectively screen, crush, separate, sort, recycle, re-use, mix, backfill and/or aerate many different materials like soil, dirt, peat, mulch, waste soil, demolition waste, industrial by-products, frozen materials, etc. You can process also wet materials.

Cobra Screening Buckets are designed to be used with excavators, wheel loaders, backhoes, telehandlers and skid steers. Thanks to robust design and fine adjustment of fragment size it's a versatile and powerful tool to ensure high quality end product and high production rate.

Cobra Buckets are light but high with volume of the bucket. You can manoeuvre Cobra Bucket with smaller base machines and save also remarkably in investment costs.

# COBRA APPLICATIONS

Cobra Screening Bucket is a perfect solution for material handling when capacity and fragment size matters. It's a light attachment with high screening capacity and adjustable fragment size. Same attachment can be used for many applications. Skip wasting material and money for transports, instead process, re-use or recycle on site with Cobra for profit.

## APPLICATIONS

- » SCREENING AND SORTING MATERIALS FOR RECYCLING
- » COMPOSTING, AERATING GREEN WASTE
- » RECYCLING AND PROCESSING OF TOPSOIL AND DIRT
- » RECYCLING DEMOLITION WASTE
- » PIPELINE AND CABLE TRENCH PADDING AND BACKFILLING
- » PREPARING TOPSOIL FOR LANDSCAPING
- » SCREENING PEAT AND MULCH
- » MIXING OR STABILIZING DIFFERENT MATERIALS
- » CRUSHING, SCREENING AND GRINDING OF RAW MATERIALS IN INDUSTRIAL APPLICATIONS
- » CRUSHING AND SCREENING FROZEN MATERIALS, LIKE SAND OR FERTILISERS





## COBRA XS -SERIES

---



3 - 13 TON



1,5 - 7 TON

Cobra XS -Series Screening Bucket is specially designed to work with 3 - 13 ton excavators and/or 1,5 - 7 ton wheel loaders, backhoes, skid steers and telehandlers. Cobra XS -Series can be installed also with a tilt-rotator and quick coupler.

With Cobra XS -Series Bucket you can effectively screen, crush, separate, sort, recycle, re-use, mix, backfill and/or aerate many different materials like soil, dirt, peat, waste soil, demolition waste, industrial by-products, frozen materials, etc. You can process also wet materials.



## COBRA S -SERIES

---



10 - 26 TON



5 - 15 TON

Cobra S -Series Screening Bucket is designed to work with 10 – 26 ton excavators and/or 5 – 15 ton wheel loaders, backhoes and telehandlers. Thanks to robust design and fine adjustment of fragment size it's a versatile and powerful tool to ensure high quality end product and high production rate.

With Cobra S -Series Buckets you can effectively screen, crush, separate, sort, recycle, re-use, mix, backfill and/or aerate many different materials like soil, dirt, peat, waste soil, demolition waste, industrial by-products, frozen materials, etc. You can process also wet materials.



## COBRA L -SERIES

---



16 - 50 TON



8 - 30 TON

Cobra L -Series Screening Bucket is designed to work with 16 – 50 ton excavators and/or 8 – 30 ton wheel loaders. In spite of light weight, it has a robust design with single or double power transmission and high inner volume of the bucket. It has also fine adjustment of fragment size. Thanks to all its innovative technical features, it's a versatile and powerful tool to ensure high quality end product and high production rate.

With Cobra L -Series Bucket you can effectively screen, crush, separate, sort, recycle, re-use, mix, backfill and/or aerate many different materials like soil, dirt, peat, waste soil, demolition waste, industrial by-products, frozen materials, etc. You can process also wet materials.



## COBRA P -SERIES

---



18 - 40 TON



10 - 30 TON

Cobra P -Series Screening Bucket is special designed for heavy applications like pipeline padding and back filling as well as communal piping or any other job where strength and durability are required. It works with 18 – 40 ton excavators and/or 10 – 30 ton wheel loaders. It has a robust design with single or double power transmission and high inner volume of the bucket. It has also fine adjustment of fragment size. Thanks to all its innovative technical features, it's a versatile and powerful tool to ensure high quality end product and high production rate.

With Cobra P -Series Bucket you can effectively screen, crush, separate, sort, recycle, re-use, mix, backfill and/or aerate many different materials like soil, dirt, peat, waste soil, demolition waste, industrial by-products, frozen materials, etc. You can process also wet materials.



COBRA K15 ORIGINAL AND FIRST EVER MADE  
SCREENING BUCKET, MADE SINCE 1993.



## COBRA K -SERIES

---



16 - 30 TON

### THE ORIGINAL SCREENING BUCKET

The first Cobra K -Series Bucket was developed and made already in 1993 and is still in use. Cobra K -Bucket has high production capacity and robust design with double power transmission for long term use. Product development is based on years of experience.

Cobra K -Series Screening Bucket is designed to work with 16 – 30 ton excavators, backhoes and telehandlers.



## COBRA OPTIONS

---

- » HD STRENGTHENING FOR BOTTOM AND SIDE PLATES (EXCL. K -SERIES)
- » XHD STRENGTHENING FOR THE FRAME (L -SERIES ONLY)
- » ADDITIONAL INTERCHANGEABLE CUTTING EDGE
- » LEVELLING PLATE
- » EXTRA SIDES FOR LIGHTER MATERIALS
- » SINGLE OR TWIN POWER TRANSMISSION (EXCL. XS2-60 AND XS2-90)
- » HYDRAULIC MOTORS WITHOUT DRAIN LINE
- » INTELLIGENT POWER CONTROL VALVE AND DRAIN OIL ELIMINATOR
- » DRUMS/DISCS FOR OTHER FRAGMENT SIZES

# COBRA DRUM/DISC ALTERNATIVES

---

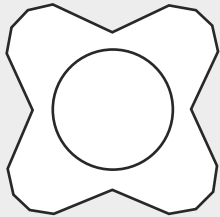

## S -MODEL

THICKNESS: 8\*,10,16 OR (25\*\*) MM  
FRAGMENT SIZES 10-50(65\*\*)MM

Standard disc for  
high quality screening

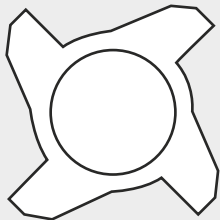

## C -MODEL

THICKNESS: 8\*,10,16 OR (25\*\*) MM  
FRAGMENT SIZES 10-50(65\*\*)MM

Special design for crushing  
and/or screening

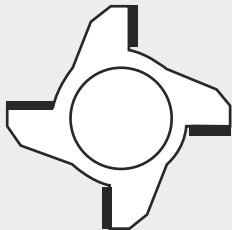

## CH -MODEL\*\*

HAMMERS: 25 X 60 MM  
FRAGMENT SIZES: APPROX. 65MM

Special design for mixing,  
aerating or crushing  
soft materials



\*for XS Buckets only

\*\*for L, P and K Buckets only



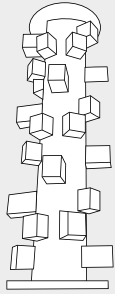

## X -MODEL

FRAGMENT SIZES: APPROX. 50 OR 75MM

Special design for crushing, separating, mixing or aerating, also for sticky and wet materials

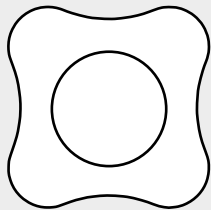

## Q -MODEL

THICKNESS: 8\*,10,16 OR (25\*\*) MM

FRAGMENT SIZES: 10-50 (65\*\*) MM

Special design for screening stony materials.

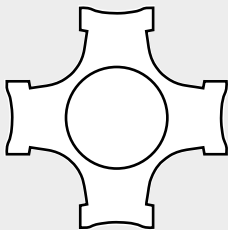

## K -MODEL

THICKNESS: 8\*,10,16 OR (25\*\*) MM

FRAGMENT SIZES: 10-50 (65\*\*) MM

Special design for soft crushing and/or screening; Ideal for sticky or frozen material.

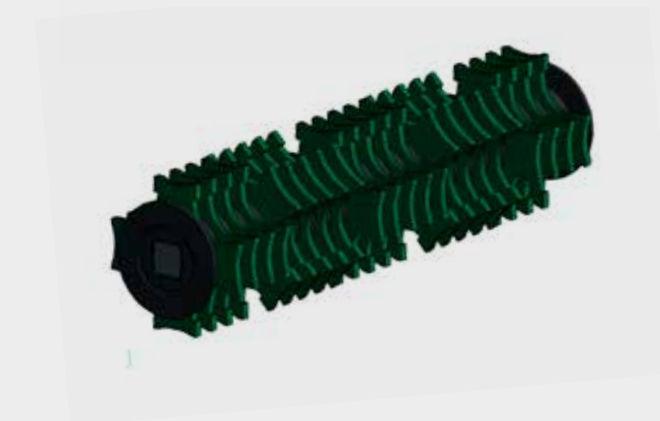

# TECHNICAL SPECIFICATION

---



Model	Base machine recommendation minimum weight (t)				Fragment sizes mm	Hydraulic settings			Volume water ISO m	Volume heap SAE m <sup>3</sup>	Screen area m <sup>2</sup>	Measures (L x W x H) cm	Approx. weight kg
	Excavators		Wheel loaders			Screening, crushing, separating, mixing pulverising, separating	Recommended hydraulic flow l/min (min-max) (120-150 rpm)	Max. input power cont/peak kW					
	1 t/m <sup>3</sup>	2 t/m <sup>3</sup>	1 t/m <sup>3</sup>	2 t/m <sup>3</sup>									
<b>XS models</b>													
XS 2-60	3,0	4,5	1,5	2,0	10,15, 20, 25, 30, 35, 40	30 - 45	15/30	1 x Gerotor	0,2	0,2	0,3	850 x 770 x 830	280
XS 2-90	5,0	7,0	2,0	3,0	10,15, 20, 25, 30, 35, 40, 50, 75	30 - 45	15/30	1 x Gerotor	0,3	0,3	0,4	1150 x 770 x 830	380
XS 2-120	7,0	9,0	3,0	4,0	10,15, 20, 25, 30, 35, 40, 50, 75	45 - 80	37,5/60	1 x Gerotor	0,5	0,6	0,6	1450 x 770 x 830	570
XS 2-150	9,0	11,0	4,0	5,0	10,15, 20, 25, 30, 35, 40, 50, 75	45 - 80	37,5/60	1 x Gerotor	0,8	0,9	0,8	1750 x 770 x 830	660
<b>S models</b>													
S 2-120	10,0	12,0	4,0	5,0	10, 15, 20, 25, 30, 35, 40, 50, 75	60 - 90	33/52	1 x Gerotor	0,7	0,8	0,6	1570 x 1020 x 1135	840
S 2-150	12,0	14,0	6,0	8,0	10, 15, 20, 25, 30, 35, 40, 50, 75	60 - 90	33/52	1 x Gerotor	0,9	1,0	0,8	1870 x 1020 x 1135	980
S 3-90	10,0	12,0	5,0	7,0	10, 15, 20, 25, 30, 35, 40, 50, 75	60 - 90	33/52	1 x Gerotor	0,7	0,8	0,6	1270 x 1165 x 1210	880
S 3-120	12,0	15,0	6,5	9,0	10, 15, 20, 25, 30, 35, 40, 50, 75	75 - 115	33/52	1 x Gerotor	0,9	1,0	0,8	1570 x 1165 x 1210	1050
S 3-150	14,0	18,0	7,5	11,0	10, 15, 20, 25, 30, 35, 40, 50, 75	75 - 115	33/52	1 x Gerotor	1,1	1,2	1,0	1870 x 1165 x 1210	1260
S 3-180	16,0	22,0	9,0	13,0	10, 15, 20, 25, 30, 35, 40, 50, 75	75 - 115	33/52	1 x Gerotor	1,3	1,4	1,3	2170 x 1165 x 1210	1480
<b>L models</b>													
L3-120	16,0	20,0	8,0	11,0	10, 15, 20, 25, 30, 35, 40, 50, 65, 75	90 - 140	48/56	1 x Gerotor	1,5	1,7	1,0	1846 x 1632 x 1492	1550
L3-180	20,0	24,0	10,0	13,0	10, 15, 20, 25, 30, 35, 40, 50, 65, 75	90 - 140	48/56	1 x Gerotor	2,2	2,4	1,5	2310 x 1632 x 1492	2000
L3-240	26,0	30,0	12,0	14,0	10, 15, 20, 25, 30, 35, 40, 50, 65, 75	180 - 280	120/180	2 x Gerotor	3,2	3,5	1,8	2910 x 1632 x 1492	2700
L4-120	22,0	25,0	10,0	13,0	10, 15, 20, 25, 30, 35, 40, 50, 65, 75	95 - 140	60/90	2 x Rad.piston	1,9	2,1	1,2	1710 x 1890 x 1800	1980
L4-180	26,0	30,0	12,0	16,0	10, 15, 20, 25, 30, 35, 40, 50, 65, 75	95 - 140	60/90	2 x Rad.piston	3,0	3,2	1,8	2310 x 1890 x 1800	2600
L4-240	32,0	38,0	14,0	18,0	10, 15, 20, 25, 30, 35, 40, 50, 65, 75	110 - 170	60/90	2 x Rad.piston	4,1	4,4	2,4	2910 x 1890 x 1800	3400
<b>P models</b>													
P3-120	18,0	22,0	8,0	11,0	10, 15, 20, 25, 30, 35, 40, 50, 65, 75	90 - 140	48/56	1 x Gerotor	1,3	1,5	1,0	1652 x 1813 x 1495	1580
P3-180	22,0	26,0	10,0	13,0	10, 15, 20, 25, 30, 35, 40, 50, 65, 75	180 - 280	120/180	2 x Gerotor	1,9	2,2	1,5	2252 x 1813 x 1495	2000
P3-240	28,0	32,0	12,0	15,0	10, 15, 20, 25, 30, 35, 40, 50, 65, 75	180 - 280	120/180	2 x Gerotor	3,0	3,3	1,8	2852 x 1813 x 1495	2850
P4-180	28,0	32,0	12,0	15,0	10, 15, 20, 25, 30, 35, 40, 50, 65, 75	180 - 280	120/180	2 x Gerotor	3,0	3,0	1,8	2310 x 1900 x 1800	2950
<b>K models</b>													
K-15	16,0	20,0	-	-	10,15, 20, 25, 30, 35, 40, 50, 65, 75	120 - 180	75 / 120	2 x Gerotor	1,0	1,1	0,9	1350 x 1200 x 1440	1490
K-120	20,0	25,0	-	-	10,15, 20, 25, 30, 35, 40, 50, 65, 75	120 - 180	75 / 120	2 x Gerotor	1,4	1,5	1,2	1350 x 1200 x 1740	1770

All values/measures/weights are approximate. Specifications subject to modifications at producer's discretion.

# CERNOS IN BRIEF

---

Cernos Oy (Ltd) is a Finland based private company producing attachment type Screening Buckets under Cobra trade name for screening and crushing applications. First Cobra Buckets have been developed and produced already over 25 years ago.

Since then the Cobra Buckets have been widely tested and approved in several applications like soil and peat screening, pipeline and cable trench padding and backfilling, recycling of wastes, processing industrial by products, etc.

All during the years we have listened to the feedback and needs of our customers and developed our products accordingly. That's why Cobra Buckets are today highly appreciated for working reliably and effectively even in most demanding circumstances as well as Cobra customer service to be the best on the market.

We at Cernos are dedicated to find new solutions for improving working methods, processes and equipment together with our partners. We'll be worth of your trust!

---

## *Cernos*

Cernos Oy (Ltd)  
Ähtärintie 41, 63700 Ähtäri, Finland  
Moukarikatu 2, 15700 Lahti, Finland

+358 44 358 3112  
info@cernos.fi  
www.cernos.fi



888-280-1710  
sales@ransomeattach.com  
www.ransomeattach.com